

Dependable Wireless Solid-State Drive (SSD)

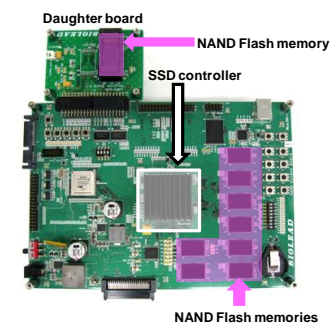
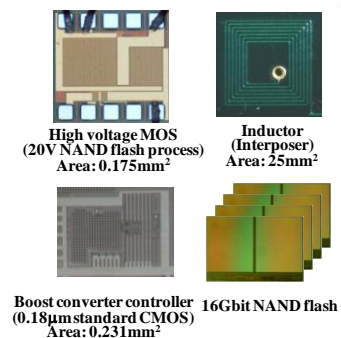
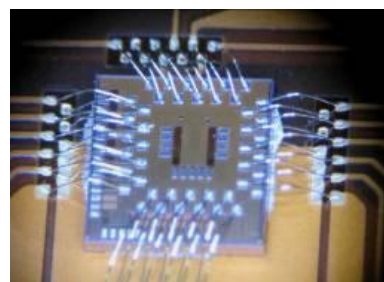
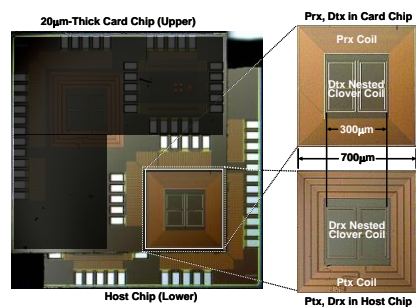
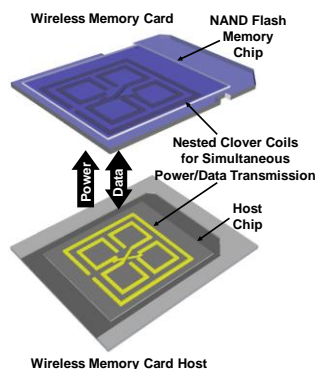

Ken Takeuchi, Chuo University
Tadahiro Kuroda, Keio University
Hiroki Ishikuro, Keio University

Objectives of Research

- **Wireless SSD/Memory card and its host system**
- **Robust against memory cell error, contact error, ESD, EMI and waterproof**
- **High-speed near field wireless communication**
 - Target : 10-50Gbps at 1mm distance
- **Wireless power delivery with MHz load variability**
 - Target : 1-3W

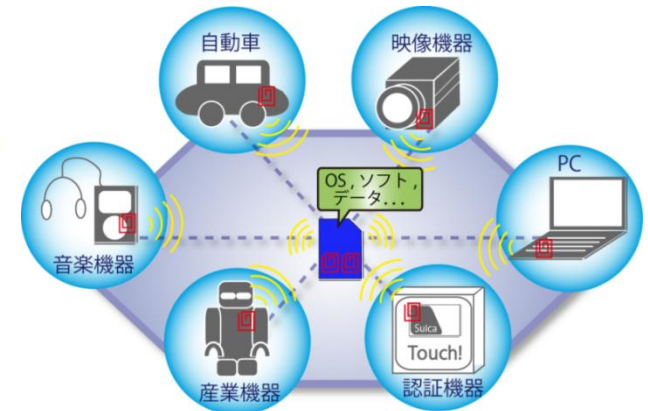
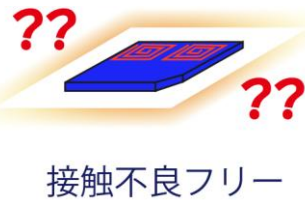
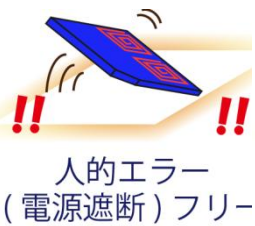
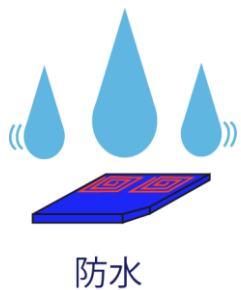

9 ISSCC Presentations

■ ISSCC 2013

- Takeuchi “Unified Solid-State Storage”
- Kuroda, Ishikuro “A 0.15-mm-Thick Non-Contact Connector for MIPI”
- Kuroda “Inductive-Coupling Wake-Up Transceiver for Non-Contact Memory Card”
- Kuroda “Retrodirective Transponder Array with Universal On-Sheet Reference for Wireless Mobile Sensor Networks”

■ ISSCC 2012

- Takeuchi “Error-Prediction LDPC”
- Kuroda, Ishikuro “7Gb/s/Link Non-Contact Memory Module”
- Ishikuro “Voltage-Boosting Wireless Power Delivery System”

■ ISSCC 2011

- Takeuchi “Asymmetric Coding for SSD”
- Kuroda, Ishikuro “12Gb/s non-contact interface”



Dependable Memory System

- Data retention error and program disturb error become worse as the memory cell is scaled.
- **ECC should be improved with the device scaling.**

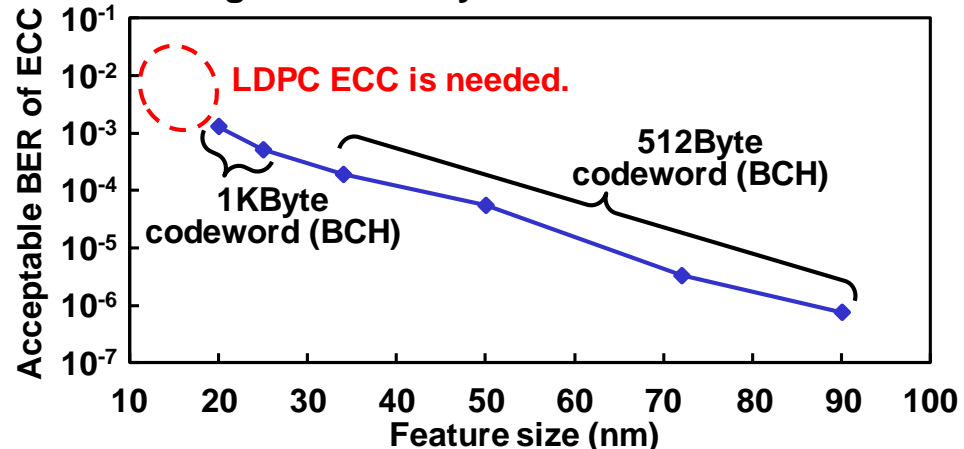
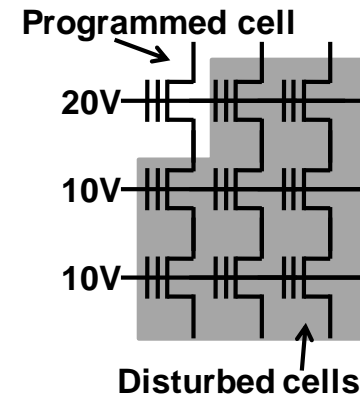
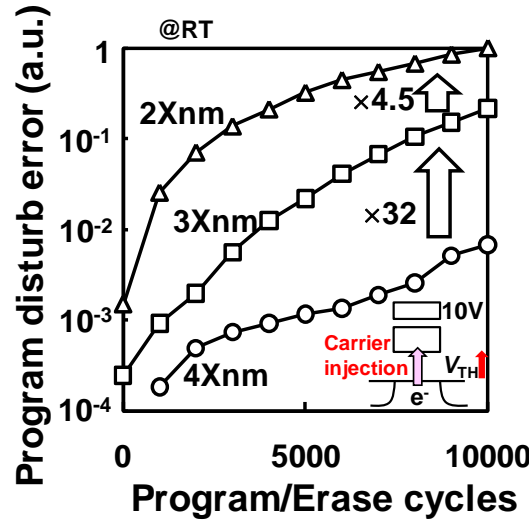
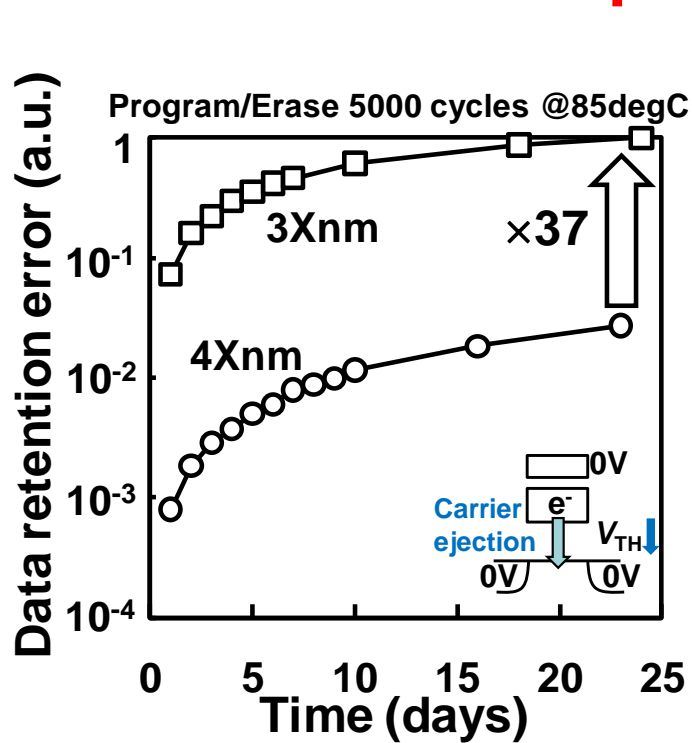

Dependable SSD System (ISSCC 2012)

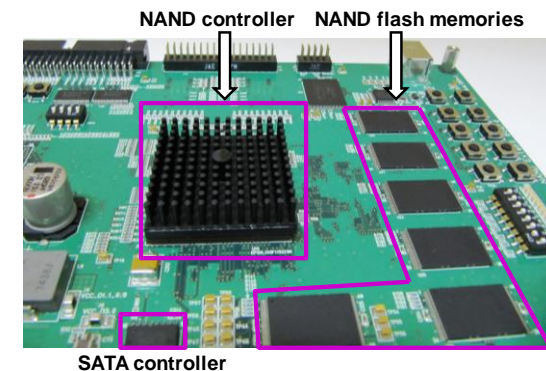
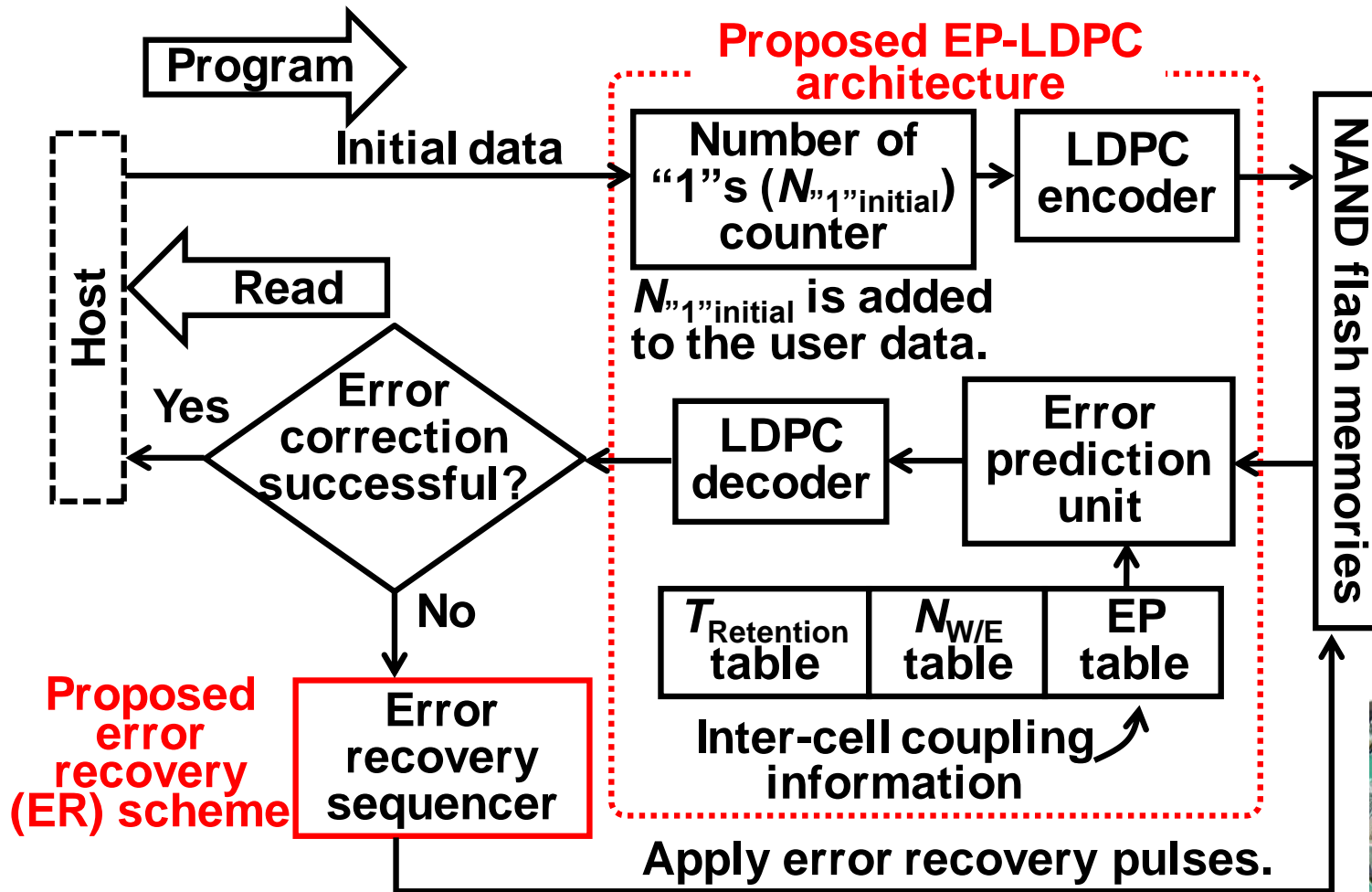

X 11 Better Reliability, Error Predicting LDPC

- Compensate the capacitive interference by using the neighboring cell data
- Compensate the V_{th} decrease during data retention by write/erase cycles and data retention time data

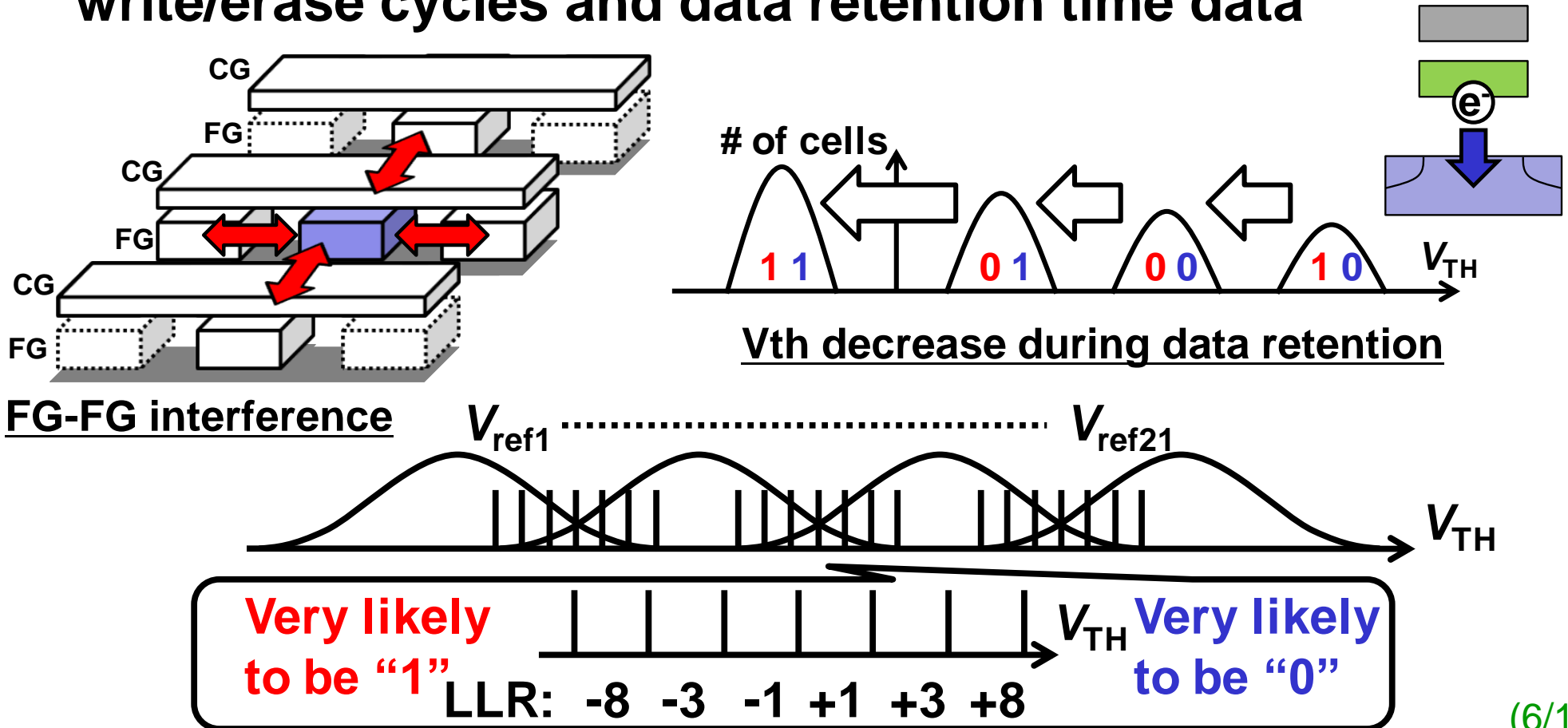

Dependable Near-Field Link

- **Near-field** provides dependable link
 - Mechanical tolerance by flexible link (for attaching/removing/vibration)
 - ESD/water-proof by hermetically seal
 - High speed ($>10\text{Gbps}$), low energy ($<1\text{pJ/b}$)
- **ThruChip Interface (TCI)**
 - Chip stacking in package
 - Lumped parameter circuit
- **Transmission Line Coupler (TLC)**
 - Module connector on circuit board
 - Distributed parameter circuit

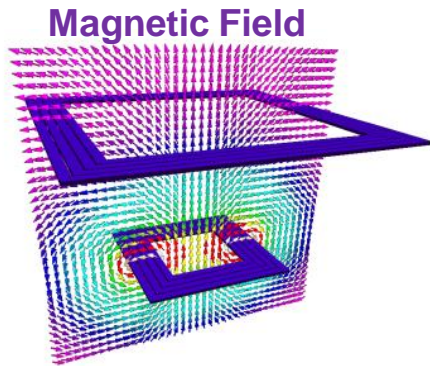

Magnetic Coupling

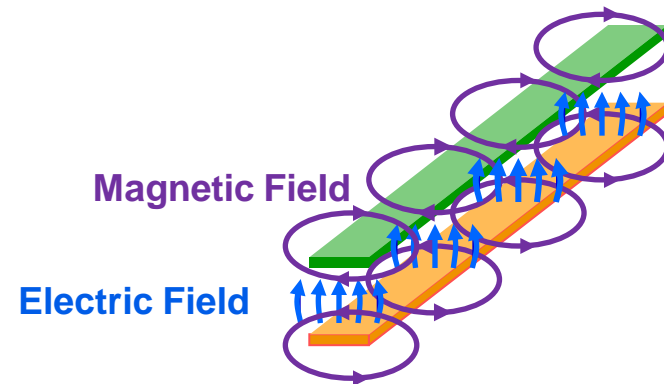

Electromagnetic Coupling

Non-Contact Connector by TLC

- Dependable module assembly is made possible

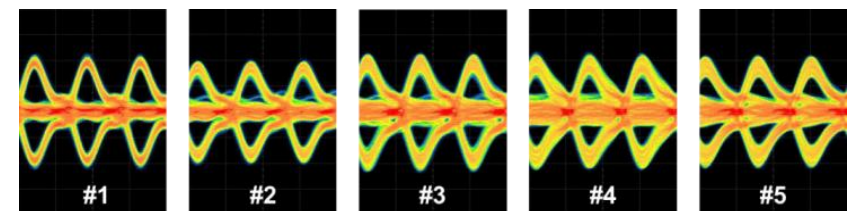
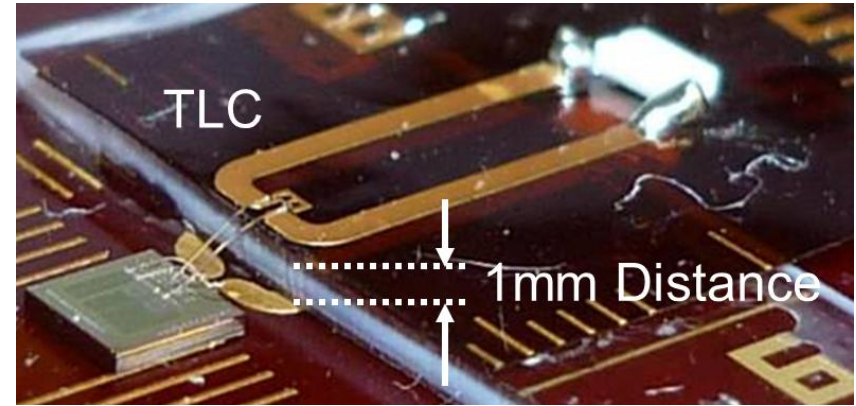
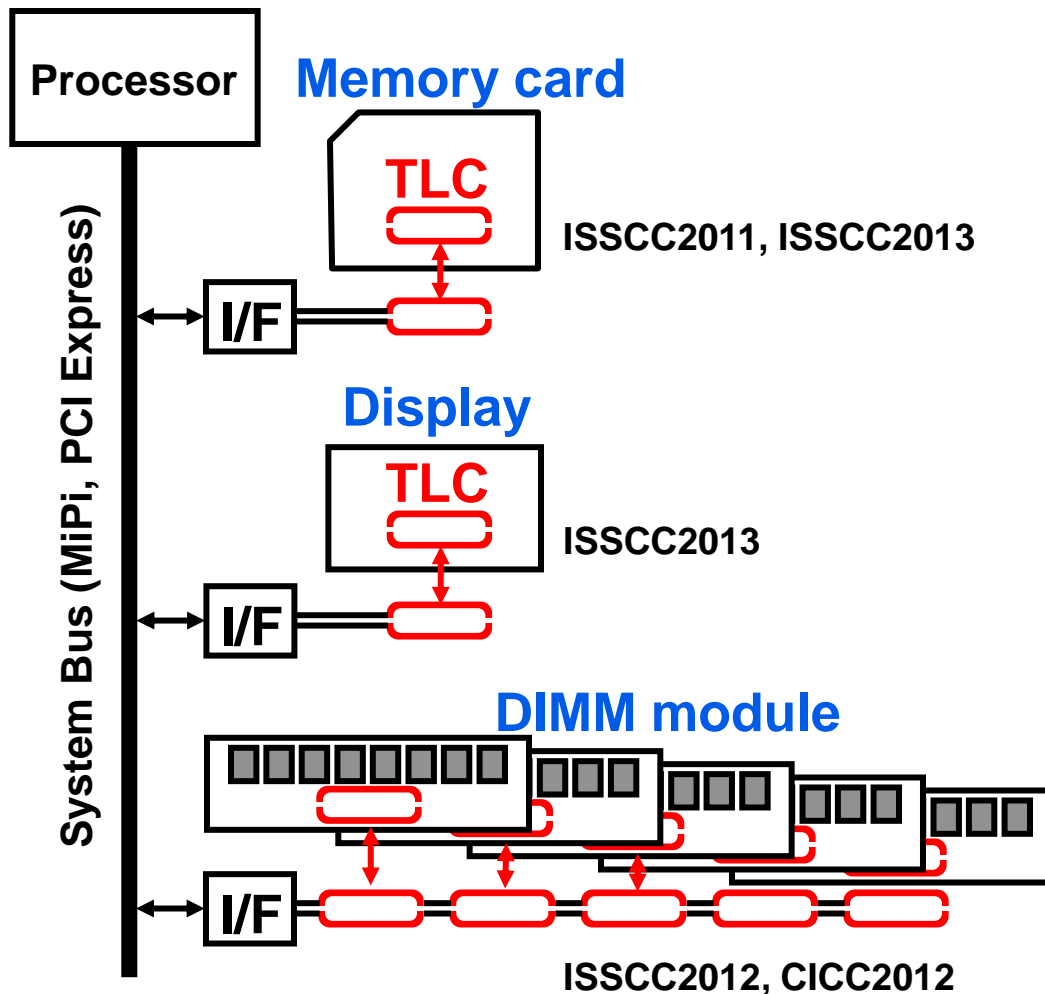

Energy equipartitioned to each memory module

Dependable Wireless Power Delivery System

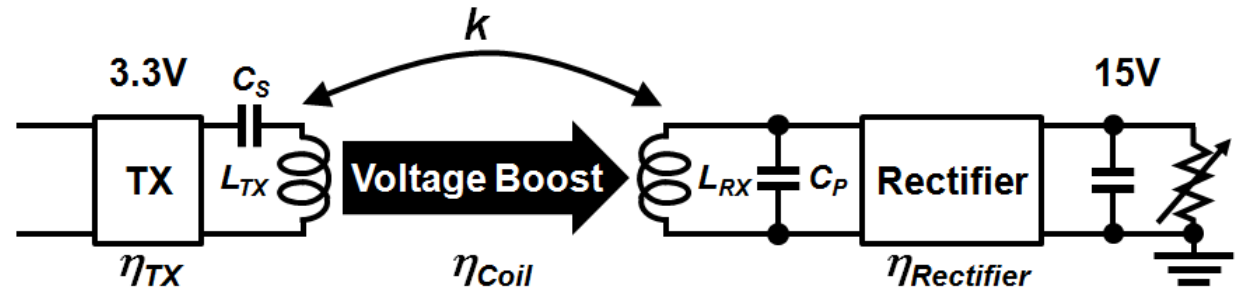
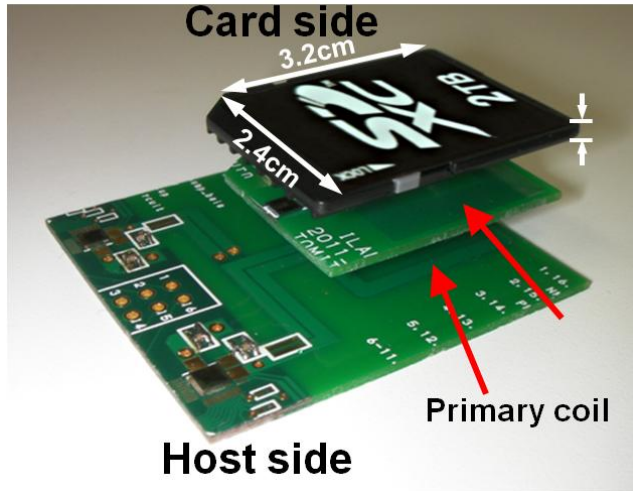

Small size, battery-less application

Requirement :

Fast load tracking and low EMI

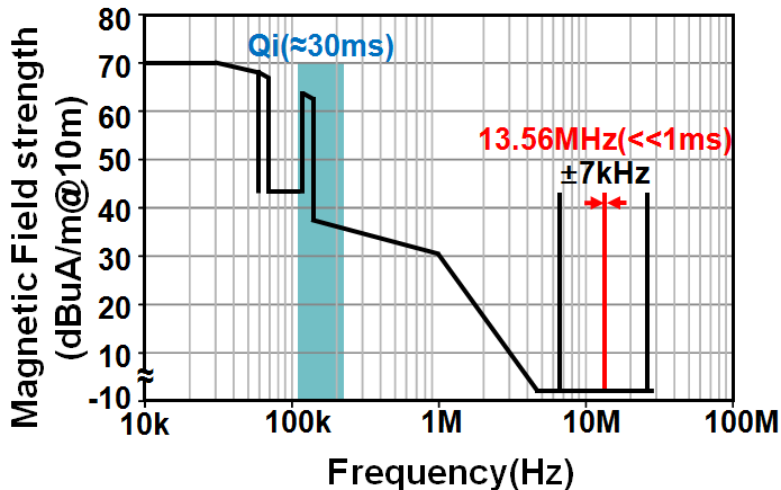

Switch between f_{res} , and $f_{res}/3$

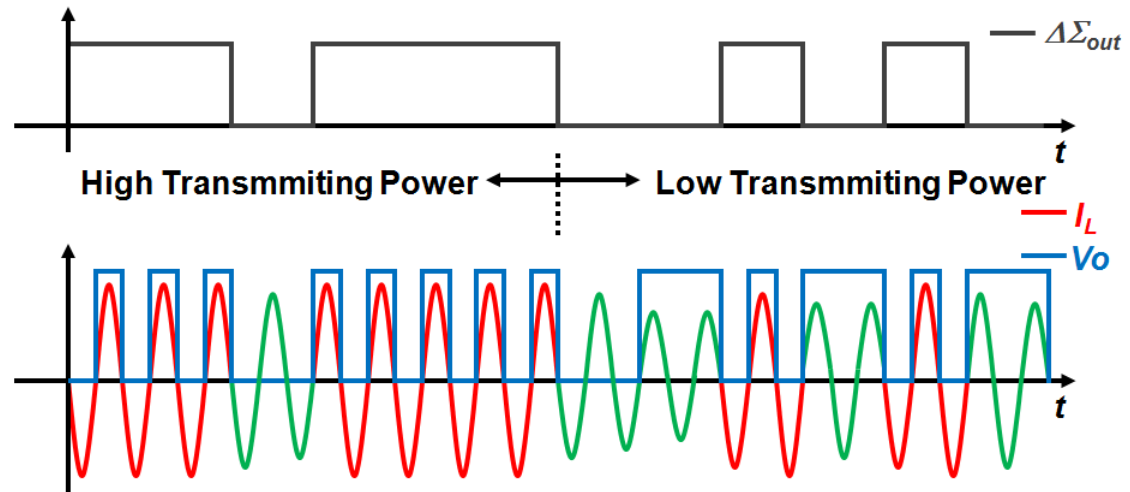

Wireless Power Delivery System

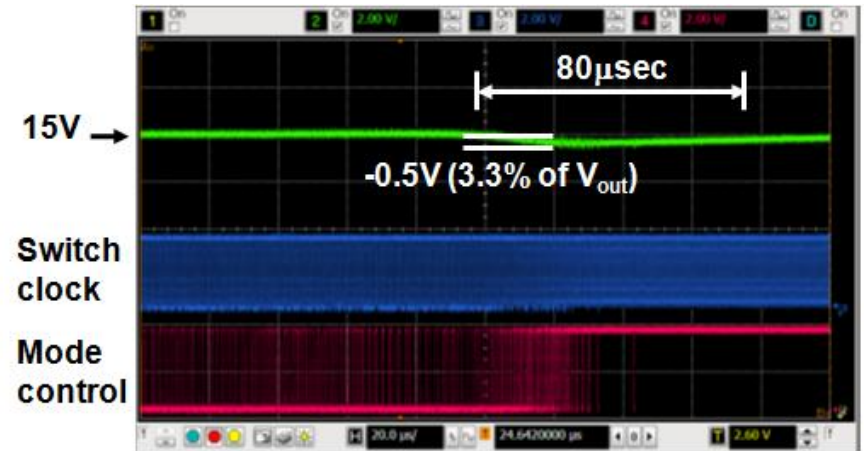
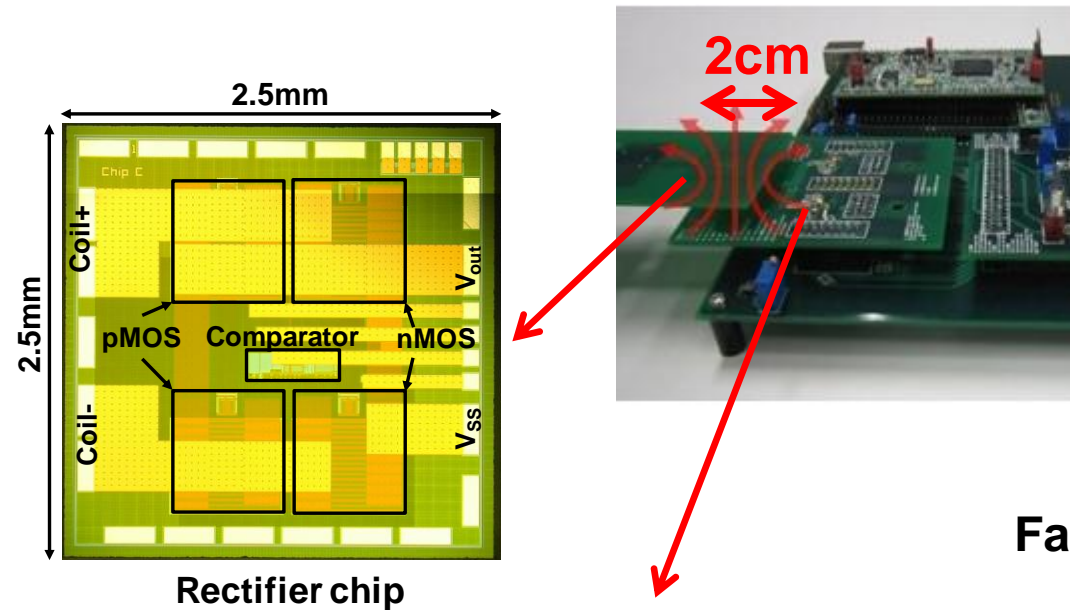

Fast response
Load transition point
(From 45mW to 500mW)

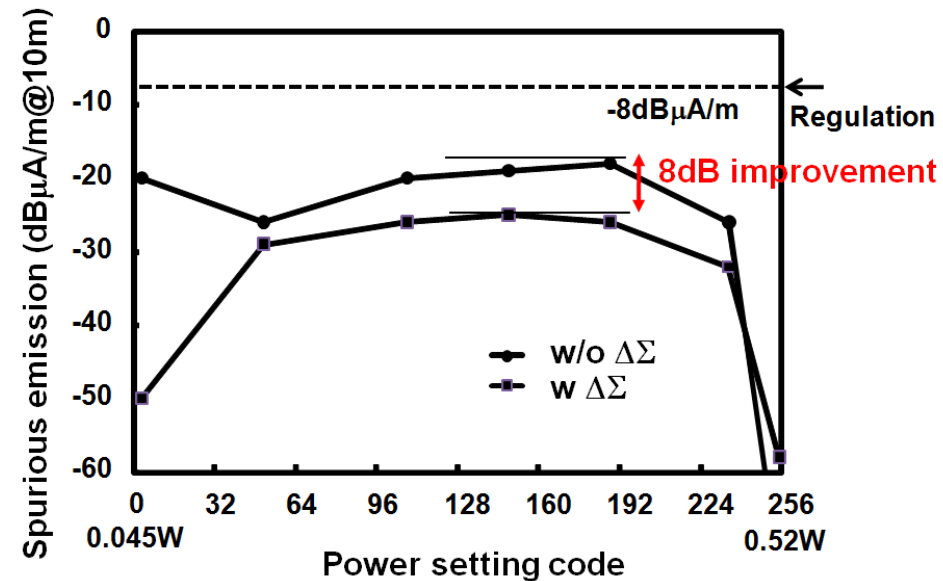
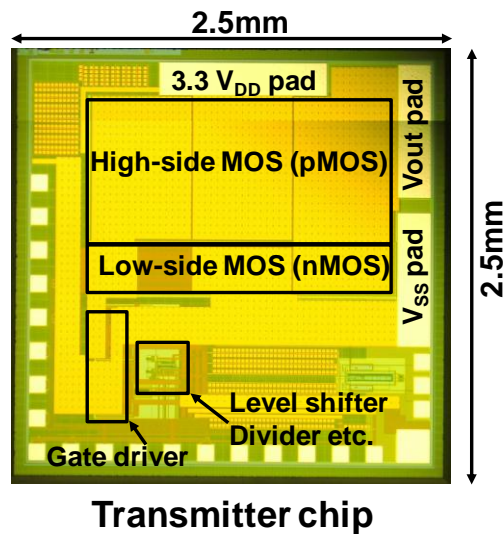

ISSCC2012, ASSCC012

Low EMI

(10/10)